

# SLIMLINE

DIRECT VENT GAS FIREPLACE

HEAT & GLO®





# SLIMLINE

SlimLine fireplaces fit where others don't. Slender profiles make unique installations a reality. Bring your vision to life with multiple models, sizes and finishing options. The ideal combination of flame, glow and logs create a fireside experience you never want to leave.

Upgrade the ambiance with the X collection. These enhanced fireplaces offer more heat, detailed high-definition logs, eye-catching LED embers, touchscreen remote control and more.



---

# CREATIVE VERSATILITY

---



## RIGHT SIZE FOR ANY SPACE

Find the right fire to fill your space. Select from 28, 32, 36 and 42-inch wide sizes. Let creative installations inspire you. At just 16 inches deep, space is no longer a constraint.



## FEEL THE REALISM

Flame, glow and logs come together for an immersive experience. Take it to the next level with the additional heat and options of the X collection, and lose yourself in the looks and warmth of your SlimLine.



## FIT YOUR STYLE

Personalize the aesthetics of the fireplace. Style the front with decorative trims and finishes, choose interior elements, and enrich the appearance with advanced selections. Opt for modern drama, authentic masonry, or somewhere in-between.





**SPACE. SIZE. SELECT.**

Consider heat output, room dimensions and venting in your space. And then select a 28, 32, 36 or 42-inch wide model.

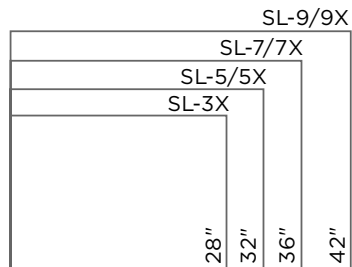

**CHOOSE YOUR MODEL**

**SL MODELS:** The ideal combination of flame, glow and logs.

**X COLLECTION MODELS:** More heat, detailed high-definition logs, eye-catching LED embers and more.

FEATURES	SL-3X	SL-5	SL-5X	SL-7	SL-7X	SL-9	SL-9X
Fireplace Width	28"	32"	32"	36"	36"	42"	42"
Room Size Fit	Small	Small to medium	Small to medium	Medium to large	Medium to large	Medium to large	Medium to large
BTU/hr Input	11,500-21,000	14,900-21,000	14,500-27,500	17,500-25,000	17,500-30,500	23,500-30,000	18,000-35,000
Stratford Brick Interior Panels	Standard (four-piece)	Optional (three-piece)	Standard (four-piece)	Optional (three-piece)	Standard (four-piece)	Optional (three-piece)	Standard (four-piece)
Tranquil Greige Brick Interior Panels	Standard	Not Available	Standard	Not Available	Standard	Not Available	Standard
Fade-Resistant Black Glass Interior Panels	Standard	Optional	Standard	Optional	Standard	Optional	Standard
Fan Kit	Standard	Optional	Standard	Optional	Standard	Optional	Standard
Touchscreen Remote Control	Standard	Optional	Standard	Optional	Standard	Optional	Standard
Wireless Wall Switch	Optional	Optional	Optional	Optional	Optional	Optional	Optional
Logs	5 high-definition logs	5 standard-definition logs	5 high-definition logs	5 standard-definition logs	5 high-definition logs	5 standard-definition logs	5 high-definition logs
Embers	LED illuminated embers	Glowing embers	LED illuminated embers	Glowing embers	LED illuminated embers	Glowing embers	LED illuminated embers
Glass	Ceramic	Tempered	Ceramic	Tempered	Ceramic	Tempered	Ceramic
Ignition System	IntelliFire Touch®	IntelliFire	IntelliFire Touch	IntelliFire	IntelliFire Touch	IntelliFire	IntelliFire Touch
Flame Turndown	50%	50%	50%	50%	50%	35	50%



## FRONT OPTIONS



### CHATEAU FORGE

Available for SL-5/5X, SL-7/7X and SL-9/9X models in handcrafted, hammered steel.

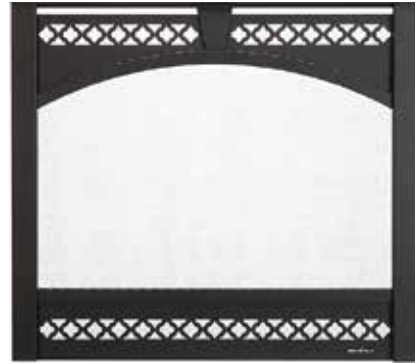

### CHATEAU

Available for all models in black, new bronze or graphite.

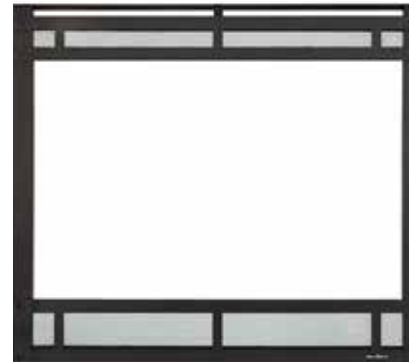

### HALSTON

Available for all models in black, new bronze or graphite.

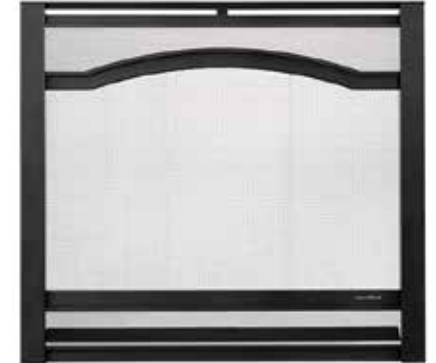

### ARCADIA

Available for SL-5/5X, SL-7/7X and SL-9/9X models in black, new bronze or graphite.



### CLEAN FACE

Available for SL-5/5X, SL-7/7X and SL-9/9X models in black, new bronze or graphite.



### FIRESCREEN

Available for all models in black.

## FINISHES

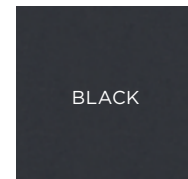

BLACK

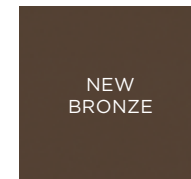

NEW  
BRONZE



GRAPHITE

## INTERIOR PANEL OPTIONS

Change the look of the fireplace with interior panel options. Choices range from brick panels that give the appearance of an authentic masonry fireplace, to reflective fade-resistant black glass for modern drama.



### STRATFORD BRICK PANELS

Included standard on X collection models. Optional upgrade for SL models.



### TRANQUIL GREIGE INTERIOR BRICK PANELS

Standard on X collection models









### FADE-RESISTANT BLACK GLASS PANELS

Included standard on X collection models. Optional upgrade for SL models



## CONTROL OPTIONS

		Wall Switch or Remote Control	On/Off	Fan Speed	Flame High/Low	Pilot Activation	AUX Function	Temp Readout	Thermostat Mode	Timer Mode	Battery Strength Indicator	Auto Battery Backup	Child Lock	Cold Climate Mode	Docking Station
<b>X COLLECTION CONTROLS</b>															
RC150		Wall	•								•	•		•	
RC400 (included standard with X collection)		Remote	•	•	•	•	•	•	•	•	•	•	•	•	•
<b>SL CONTROLS</b>															
WSK200-HNG		Wall	•	•		•					•	•			
WSK-MLT		Wall	•	•	•	•	•	•	•						
SMART-STAT-HNG		Remote	•					•	•	•					
RCT-MLT-HNG		Remote	•	•	•			•	•	•					

## SLIMLINE TECHNOLOGIES



### INTELLIFIRE IGNITION SYSTEM

The IntelliFire® ignition system (IPI) is an advanced intermittent pilot ignition system. IPI constantly monitors ignition, ensures safe functioning and conserves up to \$10/month in energy costs. IntelliFire Touch takes this technology to the next level with more safety and memory settings and a programmable wireless remote control.

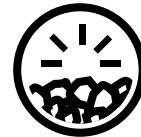

### LED EMBER BED

Add an extra layer of dimension and light to your fire. Realistic illuminated LED embers let you enjoy the ambiance, with or without the fire.



### DIRECT VENT TECHNOLOGY

With direct vent fireplaces and inserts, 100% of combustion exhaust and fumes are removed from your home. These sealed fireplaces provide optimal heat, conserve energy and ensure clean, safe indoor air quality.



### FADE-RESISTANT BLACK GLASS PANELS

A clean modern look never gets dull. Just like this black glass interior. It's hot. And looks that way, too. For the life of your fireplace.

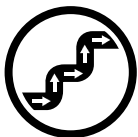

### POWER VENTING TECHNOLOGY

Fireplaces aren't just for exterior walls. A fan-powered accessory with slim venting can zigzag throughout your home—up, down, over or under—making it possible to install a gas fireplace virtually anywhere. This ensures safe fireplace operation and the best flames. Check with your local hearth professional to determine if your home or fireplace could benefit from power venting technology.

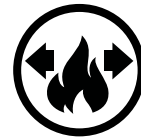

### HEAT MANAGEMENT TECHNOLOGY

Bring the warmth from your fireplace to the rest of your home, up to 20 feet away. Heat management technology can redirect up to 50% of the heat to another area, also reducing wall temperatures above the fireplace. Choose between a Heat-Zone® kit to transfer heat where you want it, or redirect up to 40% of the heat outside with a Heat-Out® kit.

# SLIMLINE SPECIFICATIONS

MODEL	FRONT WIDTH		BACK WIDTH		HEIGHT		DEPTH		GLASS SIZE	BTU/HR INPUT (NG)
	ACTUAL	FRAMING	ACTUAL	FRAMING	ACTUAL	FRAMING	ACTUAL	FRAMING		
SL-3X	33 [838]	34 [864]	22-3/4 [578]	34 [864]	32-3/8 [822]	32-3/4 [832]	16-1/4 [413]	16-1/4 [413]	24-1/8 X 16 [613 x 406]	11,500-21,000
SL-5/5X	36 [913]	37 [940]	25-3/4 [653]	37 [940]	34-3/8 [873]	34-3/4 [882]	16-5/16 [415]	16-1/4 [413]	27-3/16 X 18-1/16 [691 x 459]	14,900-21,000 (5) 14,500-27,500 (5X)
SL-7/7X	41 [1041]	42 [1067]	30-3/4 [781]	42 [1067]	37-7/8 [962]	38-1/4 [972]	16-5/16 [415]	16-1/4 [413]	32-1/16 X 21-1/2 [814 x 546]	17,500-25,000 (7) 17,500-30,500 (7X)
SL-9/9X	48 [1218]	49 [1245]	37-3/4 [959]	49 [1245]	39-9/16 [1005]	40-1/4 [1022]	16-5/16 [415]	16-1/4 [413]	39-1/16 X 23-9/16 [992 x 599]	23,500-30,000 (9) 18,000-35,000 (9X)

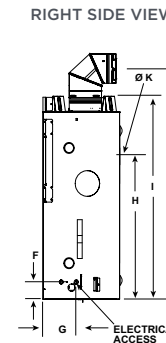
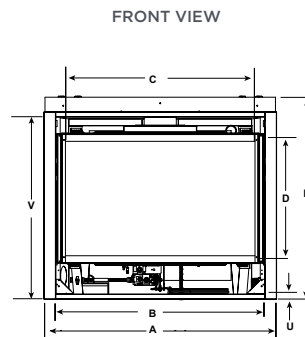
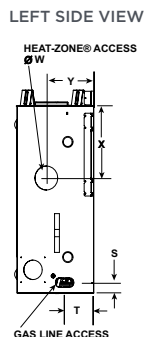
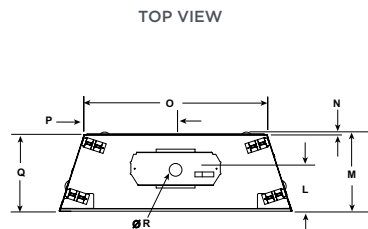

MODEL	A	B	C	D	E	F	G	H	I	J	K	L	M	N	O	P	Q	R	S	T	U	V	W	X	Y
SL-3X	33 [838]	28-1/8 [714]	24-1/8 [613]	16 [406]	32-1/8 [816]	3-1/2 [89]	6-7/8 [175]	21-3/8 [543]	32-3/8 [822]	34-1/2 [876]	8 [203]	8-3/4 [222]	16-1/4 [413]	1/2 [13]	22-3/4 [578]	11-3/8 [289]	15-7/8 [403]	6-5/8 [168]	2-1/8 [54]	6 [152]	1 [25]	28 [711]	5 [127]	14 [356]	9-1/8 [232]
SL-5/5X	36 [914]	31-1/8 [791]	27-3/16 [691]	18-1/16 [459]	34-1/16 [865]	3-9/16 [90]	6-7/8 [175]	23-3/8 [594]	34-3/8 [873]	36-7/16 [926]	8 [203]	8-13/16 [224]	16-5/16 [414]	1/2 [13]	25-3/4 [654]	12-7/8 [327]	15-7/8 [403]	6-5/8 [168]	2-3/16 [56]	6 [152]	1 [25]	30-1/16 [764]	5 [127]	14 [356]	9-1/8 [232]
SL-7/7X	41 [1041]	36-1/8 [918]	32-1/16 [814]	21-1/2 [546]	37-5/8 [956]	3-9/16 [90]	6-7/8 [175]	26-7/8 [683]	37-7/8 [962]	39-15/16 [1014]	8 [203]	8-13/16 [224]	16-5/16 [414]	1/2 [13]	30-3/4 [781]	15-3/8 [391]	15-7/8 [403]	6-5/8 [168]	2-3/16 [56]	6 [152]	1 [25]	33-9/16 [853]	5 [127]	14 [356]	9-1/8 [232]
SL-9/9X	48 [1219]	43 [1092]	39-1/16 [992]	23-9/16 [599]	39-9/16 [1005]	3-9/16 [90]	6-7/8 [175]	28-7/8 [733]	39-7/8 [1013]	41-15/16 [1065]	8 [203]	8-13/16 [224]	16-5/16 [414]	1/2 [13]	37-3/4 [959]	18-7/8 [479]	15-7/8 [403]	6-5/8 [168]	2-3/16 [56]	6 [152]	1 [25]	35-9/16 [903]	5 [127]	14 [356]	9-1/8 [232]

Dimensions above are in inches and millimeters. Product information is not complete and is subject to change without notice. Product installation must adhere strictly to instructions shipped with product. We recommend measuring individual units at installation. Assumes the use of 1/2-inch drywall. NOTE: Combustible material should not cover the face. Make sure you do NOT cover the decorative door opening.

Refer to installation manual for detailed specifications on installing this product. Heat & Glo reserves the right to update units periodically. The flame and ember appearance may vary based on the type of fuel burned and the venting configuration used. Actual product appearance, including flame, may differ from product images.

## EFFICIENCIES

EnerGuide (CSA P.4.1-15) EnerGuide is a rating used in Canada to measure annual fireplace efficiency.

MODEL	SL-3X	SL-5	SL-5X	SL-7	SL-7X	SL-9	SL-9X
EFFICIENCY	69.1%	57.9%	64.0%	59.0%	66.4%	62.1%	69.0%

For complete information on this model, please contact us at:

**HEAT & GLO**  
No one builds a better fire

Web: [heatnglo.com](http://heatnglo.com)  
Phone: (888) 427-3973 (952) 985-6000  
Email: [info@heatnglo.com](mailto:info@heatnglo.com)

[facebook.com/HeatandGlo](https://www.facebook.com/HeatandGlo)  
[twitter.com/HeatandGlo](https://twitter.com/HeatandGlo)  
[youtube.com/HeatandGlo](https://www.youtube.com/HeatandGlo)

### LIMITED LIFETIME WARRANTY\*

The strongest in the industry, Heat & Glo® provides a limited lifetime warranty on the most important aspects: firebox and heat exchanger.

\*For full warranty details, go to [www.heatnglo.com](http://www.heatnglo.com).

Fireplace glass and other surfaces get extremely HOT and can cause severe burns if touched. Do not remove the protective safety screen from the front of the glass. Keep a safe distance away. To learn more visit [www.heatnglo.com/fireplacesafety](http://www.heatnglo.com/fireplacesafety)

Google, YouTube and Google Home are trademarks of Google LLC. Amazon, Alexa, and all related logos are trademarks of Amazon.com, Inc. or its affiliates.

HNG-1148U-0420

