

Models:

ODGO324-IPI-LP
ODGO324-IPI-NG

Outdoor Burner and Log Set



Installation and service of this appliance should be performed by qualified personnel. Hearth & Home Technologies suggests NFI certified or factory-trained professionals, or technicians supervised by an NFI certified professional.





Check with your local building code agency before you begin installation to ensure compliance with local codes, including the need for permits and follow-up inspections. If you encounter any problems regarding code approvals, or if you need clarification of any of the instructions contained here, contact the Technical Services Dept., Hearth & Home Technologies Inc., www.hearthnhome.com.

CAUTION



DO NOT DISCARD THIS MANUAL

- Important operating and maintenance instructions included.
- Read, understand and follow these instructions for safe installation and operation.
- Leave this manual with party responsible for use and operation.



⚠ WARNING



If the information in these instructions is not followed exactly, a fire may result causing property damage, personal injury, or death.

- Do not store or use gasoline or other flammable vapors and liquids in the vicinity of this or any other appliance.
- **What to do if you smell gas:**
 - Do not try to light any appliance.
 - Do not touch any electrical switch. Do not use any phone in your building.
 - Immediately call your gas supplier from a neighbor's phone. Follow the gas supplier's instructions.
 - If you cannot reach your gas supplier, call the fire department.
- Installation and service must be performed by a qualified installer, service agency, or the gas supplier.

⚠ WARNING



HOT! DO NOT TOUCH. SEVERE BURNS MAY RESULT. CLOTHING IGNITION MAY RESULT.

Glass and other surfaces are hot during operation and cool down.

- Keep children away.
- CAREFULLY SUPERVISE children in same room as appliance.
- Alert children and adults to hazards of high temperatures.
- Do NOT operate with protective barriers removed.
- Keep clothing, furniture, draperies and other combustibles away.

In the Commonwealth of Massachusetts:

- This appliance must be installed by a licensed plumber or gas fitter.
- The chimney flue damper, when used with gas logs, will be welded open or completely removed.
- A CO detector shall be installed in the room where the appliance is installed.

Note: An arrow (➡) found in the text signifies change in content.

**Read this manual before installing or operating this appliance.
Please retain this owner's manual for future reference.**

Congratulations

Congratulations on selecting a Hearth & Home Technologies gas log set—an elegant and clean alternative to burning wood. The Hearth & Home Technologies gas log set you have selected is designed to provide the utmost in safety, and reliability.

As the owner of this new outdoor gas log set, you'll want to read and carefully follow all of the instructions contained in this owner's manual. Pay special attention to all cautions and warnings.

This owner's manual should be retained for future reference. We suggest you keep it with your other important documents and product manuals.

The information contained in this owner's manual, unless noted otherwise, applies to all models and gas control systems.

Homeowner Reference Information	<i>We recommend that you record the following pertinent information about your gas log set:</i>
Model Name: _____	Date purchased/installed: _____
Serial Number: _____	Location on appliance: _____
Dealership purchased from: _____	Dealer phone: _____
Notes: _____	

Listing Label Information/Location

The model information regarding your specific gas log set can be found on the rating plate.

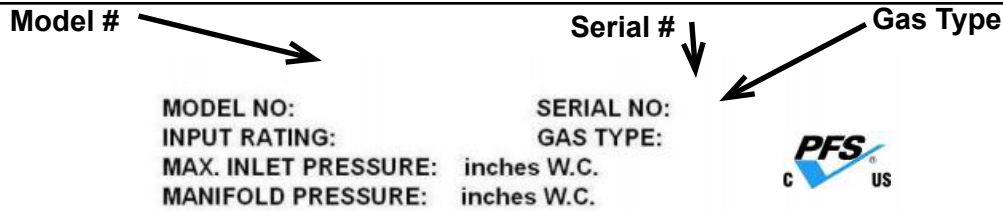

HEARTH AND HOME TECHNOLOGIES
ANGIER, NC 27501

Design complies with ANSI Z21.60b-2012 CSA 2.26-2012 decorative appliances for installation in solid-fuel burning fireplaces. The minimum inlet gas supply pressure for the purpose of input adjustment is 7 inches W.C. The minimum size fireplace opening is " W x " H x " D.
WARNING: For installation in a solid-fuel burning fireplace only. The fireplace chimney must have a permanent vent opening to the atmosphere of not less than square inches or as determined from the manufacturer's installation instructions.
WARNING: Improper installation, adjustment, alteration, service or maintenance can cause property damage, personal injury or loss of life. Refer to the owner's information manual provided with this appliance. Installation and service must be performed by a qualified installer, service agency or the gas supplier.

WARNING

Improper installation, adjustment, alteration, service or maintenance can cause injury or property damage. Refer to the owner's information manual provided with this appliance. For assistance or additional information consult a qualified installer, service agency or the gas supplier.

CAUTION



Sharp Edges

- Wear protective gloves and safety glasses during installation.



A. Design and Installation Considerations

The Gas Log Hearth Kit consists of the following:

- Log Set
- Burner Pan/Grate Assembly
- Lava Rock
- Damper Stop

B. Tools and Supplies Needed

Tools and supplies normally required for installation:

Pliers
Phillips screwdriver
Tape measure
Crescent wrenches
Gas shutoff valve
Non-corrosive leak check solution
3/4 in. wrench, 7/16 in. wrench

C. Important!

- Do not remove any of the attached metal plates, which contain important safety and operating information.
- Keep the appliance area clear and free of all combustible materials, gasoline and other flammable vapors and liquids.
- Any safety screen or guard removed during servicing must be replaced before operation.
- **A qualified service technician must perform installation and repair.** The appliance should be inspected and cleaned annually by a qualified service technician. More frequent cleaning may be required due to excessive lint, dust, pet hair, etc. It is imperative that the control compartments, burners and air passageways are unobstructed during operation.

WARNING



Fire Risk
Exhaust Fumes Risk

- Do NOT use this appliance as a "vent-free" heater.



The flue must be permanently open according to Tables 1 and 2.

WARNING



HOT! DO NOT TOUCH.
SEVERE BURNS MAY RESULT.
CLOTHING IGNITION MAY RESULT.



Glass and other surfaces are hot during operation and cool down.

- Keep children away.
- CAREFULLY SUPERVISE children in same room as appliance.
- Alert children and adults to hazards of high temperatures.
- Keep clothing, furniture, draperies and other combustibles away.

- Review proper placement of logs,lava rock. Check the wiring.
- Ensure there are no gas leaks.
- Ensure the flow of combustion and ventilation air is not obstructed (front grilles and vent caps).
- Before installing into a solid fuel burning fireplace, the chimney and firebox should be inspected and cleaned to remove soot, creosote, ashes, paint, bird nests etc.
- Annual examination of the chimney must be performed by a qualified agency to ensure proper ventilation of flue gases created by this appliance.
- Have the chimney and adjacent structure inspected and cleaned by qualified professionals. Hearth & Home Technologies recommends that NFI or CSIA certified professionals, or technicians under the direction of certified professionals, conduct a minimum of an **NFPA 211 Level 2** inspection of the chimney.
- Replace component parts of the chimney and fireplace as specified by the professionals.
- Ensure all joints are properly engaged and the chimney is properly secured.
- Do not allow fans to blow directly into the fireplace. Avoid any drafts that alter burner flame pattern.
- Do not use a blower insert, heat exchanger insert or other accessories not approved for use with this appliance.
- This appliance must have a screen in place while the appliance is in operation and, unless other provisions for combustion air are provided, the screen shall have an opening for introduction of combustion air.
- Solid fuels shall not be burned in a fireplace where a decorative appliance is installed.
- If glass doors are present, the **glass doors must be fully opened** while appliance is in operation.

 **WARNING**

Do NOT use this appliance if any part has been under water. Immediately call a qualified service technician to inspect the appliance and to replace any part of the control system and any gas control which has been under water.

D. Appliance Certification

This appliance is design certified by PFS under the **ANSI Z21.60b-2012 or CSA 2.26b-2012, Decorative Appliances for Installation in Solid-fuel Burning Fireplaces**. Installation and the provisions for combustion and ventilation air must conform to the **National Fuel Gas Code, ANSI Z223.1/ NFPA 54**, or the **CSA B149.1, Natural Gas and Propane Installation Code**.

E. Gas Supply Connection

A 3/8 in. flared fitting has been installed on the gas valve inlet at the factory. Ensure fittings are of the appropriate size and type on the gas line connection. If the tubing has to be cut to length be sure to use the proper cutting and flaring tool. Also, be careful not to crimp the tubing while bending. If the tubing becomes crimped, do not use for installation.

Gas resistant pipe compound must be used on all threaded male connections to ensure a tight seal.

F. Gas Pressure

Proper input pressures are required for optimum appliance performance. Gas line sizing requirements need to be made following **NFPA51**.

- Gas Supply Pressure: Minimum inlet gas supply pressure must be 7.0 in. W.C. for natural gas or 11 in. W.C. for LP gas for the purpose of input adjustment. Maximum inlet gas pressure must not exceed 10.5 in. W.C. for natural gas or 13 in. W.C. for LP gas. The gas line supplying the appliance must be sufficient size to furnish the appropriate supply pressure to the appliance while operating in the “High” setting.
- Pressure tap screws must be closed before turning gas on to the appliance.
- Gas Line Pressure Test: Perform pressure test according to state and local code (if pressure exceeds 1/2 in. psi (3.5 kPa)) before appliance is connected. Be sure to release air pressure from the gas line before connection is made to the appliance. Excessive pressure will damage the gas control and may cause a gas leak.
- Gas Leak Test: Make sure the gas connections are tight. Turn on the gas and coat each joint with a non-corrosive gas leak check solution. Air bubbles will form indicating any leaks. DO NOT USE A FLAME OR ANY TYPE OF IGNITION SOURCE TO CHECK FOR LEAKS. All leaks must be corrected before proceeding with installation.
- The appliance must only be installed in a solid-fuel burning fireplace with the flue damper clamped open according to Tables 1 and 2. The fireplace must be constructed of non-combustible material.
- The minimum permanent free opening (in square inches) that must be provided by the fireplace chimney or damper to vent the flue gases is provided in Tables 1 and 2. If the free opening is smaller than the specified area, do not use this appliance.
- The damper must be removed or fixed in a manner in which will secure it open. Some jurisdictions require the damper to be removed or permanently welded fully open. Check with state and local codes.
- Be sure that the chimney is completely unobstructed to ensure proper ventilation of flue gases including carbon monoxide (CO). CO (a poisonous gas) is tasteless, odorless, colorless and undetectable without proper equipment.
- Refer to Table 3 to determine minimum fireplace opening requirements before proceeding.

 **WARNING**



Fire Risk
Explosion Risk

- High pressure will damage valve.
- Disconnect gas supply piping BEFORE pressure testing gas line at test pressures above 1/2 psig.
 - Close the manual shutoff valve BEFORE pressure testing gas line at test pressures equal to or less than 1/2 psig.



 **WARNING**



Fire Risk
Explosion Risk

- Verify inlet pressures.
- High pressure may cause overfire condition.
 - Low pressure may cause explosion.
- Install regulator upstream of valve if line pressure is greater than 1/2 psig.



 **WARNING**



Asphyxiation Risk

This appliance produces carbon monoxide (CO).

- The free opening areas (in square inches) of the chimney damper as shown in the following tables must be met.
- User must make sure damper is locked open.
- The installer is responsible to ensure proper ventilation of flue gases before appliance is used.

Fire needs to draft properly for safe operation.

Table 1 for Factory Built Fireplaces

Free Opening Area (in square inches) of Chimney Damper for Venting combustion

Chimney Ht. (Feet)*	ODGO 324 LP Gas	ODGO 324 Natural Gas
10	35.3	not approved
15	26.4	38.5
20	22.1	31.2
25	18.1	27.3
30	17.3	24.6
35	15.9	22.1

Table 2 for Masonry Built Fireplaces

Free Opening Area (in square inches) of Chimney Damper for Venting combustion

Chimney Ht. (Feet)*	ODGO 324 LP Gas	ODGO 324 Natural Gas
6	49.2	64
8	45.5	59.7
10	41.7	54.3
15	37.7	48.8
20	34.3	44.4
30	31.2	40.3

Table 3 for Minimum Fireplace Dimensions

Log Set	Front Opening	Depth	Height	Rear Width	Natural BTU	Propane BTU
ODGO324	34 in.	23 in.	22 in.	22 in.	88,000	80,000

G. Inspect the Appliance and Components

- Remove the contents from the carton labeled “Burner”. Attached to the burner are tags identifying the manufacturer name, serial number, model number (including gas log size), BTU ratings, gas type, etc.
- Review the attached tags before proceeding. Ensure that all minimum fireplace dimension requirements are achieved using Table 3 . See Figure 1. Ensure the gas type provided in the fireplace coincide with the gas type marked on the tag.
- An On/Off switch is provided as part of the assembly. It is located on the front right side of the burner assembly as shown in Figure 3A.



Figure 1 Measure Firebox

- The burner is assembled with the controls installed at the factory and is designed to connect one end of the 3/8 in. supply line before placing inside the fireplace. Ensure the connection is tightened using a 3/4 in. wrench.
- Place the burner towards the rear and center of the fireplace and connect to the gas line. Follow instructions in “F. Gas Pressure” to check for gas leaks.
- IPI models include a battery box which holds 2 “D” size batteries. The battery box should be placed in the right front corner of your fireplace and covered with the log cover as shown in Figure 3.

Figure 3 Battery Box and Cover (for IPI units only)

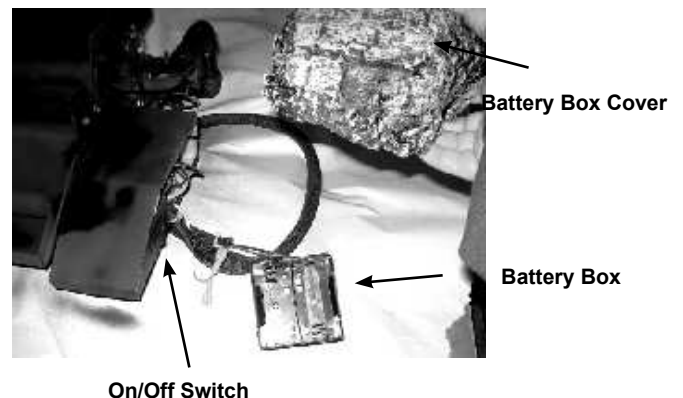

H. Lava Rock Installation

- Pour Lava Rock into the burner pans to the point where the burner pipe is covered. See Figure 5.. Be sure not to cover pilot assembly.
- **Inspect the pilot burner to ensure it is clear of any lava rock.**
- The gas burns at the point of the least resistance. In case of an uneven flame pattern it may be necessary to adjust the materials in the pans (using an object such as a screwdriver) to achieve the desired effect.
- Place desired amount of lava granules on the floor of the fireplace. (Lava granules may contain moisture which, when heating, may cause it to pop out during installation and set-up.) Ensure the controls and switches are unobstructed after the granules are installed.

Figure 5 Lava

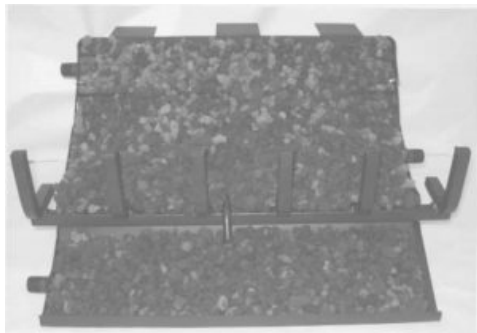

Note: The state of Massachusetts requires that the chimney flue damper, when used with gas logs, be welded open or completely removed. In the Commonwealth of Massachusetts this appliance must be installed by a licensed plumber or gasfitter.

I. Inspect the Venting System

The fireplace venting system is designed and constructed to develop a positive flow adequate to remove flue gases to the outside atmosphere. See fireplace installation instructions.

- The gas burns at the point of the least resistance. In case of an uneven flame pattern it may be necessary to adjust the materials in the pans (using an object such as a screwdriver) to achieve the desired effect.
- Place desired amount of lava granules on the floor of the fireplace. (Lava granules may contain moisture which, when heating, may cause it to pop out during installation and set-up.) Ensure that the controls and switches are unobstructed after the granules are installed. **DO NOT COVER THE AIR MIXER LOCATED ON THE LOWER LEFT SIDE OF THE BURNER.**
- Place logs as shown in Sections S thru Z.
- Place accent logs around burner on floor of fireplace.

⚠ CAUTION

- Logs can get very hot. Handle only when they are cool.

J. Damper Stop Installation Instructions

Included in the burner assembly box is a damper stop clamp which attaches to the damper, if fireplace is constructed with a damper, as shown (Figure 8). Install the clamp to the damper ensuring that the minimum requirements (Tables 1 and 2) are achieved. Use a 7/16 in. wrench to secure the clamp to the damper. If the damper clamp provided does not fit your application, other means of securing the proper opening must be provided by the installer.

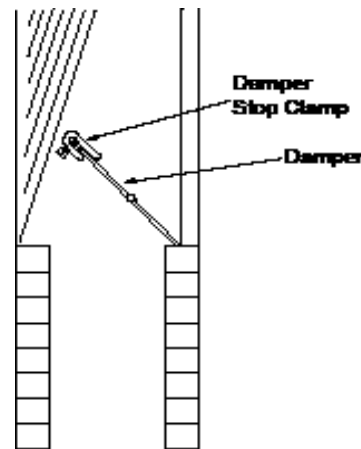

Figure 8 Damper Stop Clamp

	⚠ WARNING	
	Fire Risk Explosion Risk Personal Injury Risk	
	Failure to position the parts in accordance with the diagrams provided with the log packages or failure to use only parts approved with this appliance may result in property damage or personal injury.	

	⚠ WARNING	
	Fire Risk Explosion Risk Personal Injury Risk	
	An explosion could occur if a connection is made directly to an unregulated propane (LP) tank.	

K. Cleaning and Maintenance Instructions

Always remember:

- Do not place any combustible material near the appliance.
- Do not place any paper, trash or other material on the log set or in the fireplace.
- Do not touch any part of the appliance when it is in operation.
- Do not operate this appliance without the fireplace screen closed.

Your appliance is designed to be virtually maintenance free, although periodic visual inspection and cleaning is required. Follow the instructions below for the correct procedures. An annual examination and cleaning the venting system by a qualified person is also recommended.

CAUTION

Before cleaning the appliance, be sure it is turned completely off. The pilot should also be turned off. The unit must be completely cooled.

Do not allow soot to build up on the logs

Your logs require little care. Keep the burner assembly, logs and burner area surrounding the logs clean by brushing with a dry paint brush at least twice a year.

- Always turn off the gas to the pilot before cleaning. For relighting, refer to Section P Thru R. Lighting Instructions.
- Always keep the appliance clean and free from combustible materials, gasoline and other flammable vapors and liquids.
- Never obstruct the flow of combustion and ventilation air. Keep the front of the appliance clear of all obstacles and materials.
- Leave clearance of at least 36 in. from the front of the fireplace.

L. Lighting Instructions • IPI Pilot Valve (IPI)

FOR YOUR SAFETY READY BEFORE LIGHTING

WARNING: If you do not follow these instructions exactly, a fire or explosion may result causing property damage, personal injury or loss of life.

- A. This appliance is equipped with an intermittent Pilot ignition (IPI) device which automatically lights the burner. **DO NOT** try to light the burner by hand.
- B. **BEFORE LIGHTING**, smell all around the appliance area for gas. Be sure to smell next to the floor because some gas is heavier than air and will settle on the floor.

WHAT TO DO IF YOU SMELL GAS

Do not try to light any appliance.

Do not touch any electrical switch: do not use any phone in your building.

Immediately call your gas supplier from a neighbor's phone. Follow gas supplier's instructions.

If you cannot reach your gas supplier, call the fire department.

- C. Do not use this appliance if any part has been under water. Immediately call a qualified service technician to inspect the appliance and replace any part of the control system and any gas control which has been under water.

WARNING

DO NOT CONNECT 110 VAC TO THE CONTROL VALVE.

-Improper installation, adjustment, alteration, service or maintenance can cause injury or property damage.

-This appliance needs fresh air for safe operation and must be installed so there are provisions for adequate combustion and ventilation.

-If not installed, operated, and maintained in accordance with the manufacture's instructions, this product could expose you to substances in fuel or fuel combustion which are known to the State of California to cancer, birth defects or other reproductive harm.

-Keep burner and control compartment clean.

CAUTION

Hot while in operation. Do not touch. Keep children, clothing, furniture, gasoline and other liquids having flammable vapors away.

LIGHTING INSTRUCTIONS IPI

1. Turn off all electric power to the appliance.
2. This appliance is equipped with an ignition device which automatically lights the burner. **DO NOT** try to light the burner by hand.
3. Wait (5) minutes to clear out any gas. Then smell for gas, including near the floor. If you smell gas, **STOP!** Follow "B" in the Safety Information above. If you do not smell gas, go to the next step.
4. Turn on all electric power to the appliance.
5. To light the burner, flip the ON/OFF switch to the "ON" position (the ON/OFF switch may include a wall switch, if so equipped).
6. If the appliance will not operate, follow the instructions "To Turn Off Gas to Appliance" and call your service technician or gas supplier.

TO TURN OFF GAS TO APPLIANCE

1. Turn off all electric power to the appliance if service is to be performed.
2. Flip the ON/OFF switch to the "OFF" position.

Gas Valve

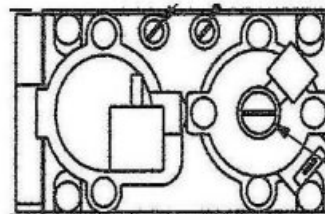

M. Frequently Asked Questions

Can I close the glass doors on my fireplace when using my gas logs?

No. The gas log sets are designed for use in fireplaces with all fireplace doors fully opened. Operating your log set with the doors closed will cause overheating, premature failure of valve systems, and will void the warranty of your log set.

What sort of maintenance do gas logs require?

Vented gas logs do not require regular maintenance. However, it is a good idea to have valves, pilots and gas connections on your set periodically inspected by a hearth professional. Although it is not required maintenance, annually refurbishing the ember material and periodic cleaning of the logs will help maintain your set's beauty and realism.

Can I burn real wood along with my gas logs?

No. The intense heat of a wood fire will damage your logs, burners, grates and valves, and will void your warranty.

Will gas logs help my chimney that drafts poorly?

No. Improper or poor draft will not be helped by gas logs. Please have your chimney inspected by a hearth professional or chimney sweep in order to determine how to correct the problem.

Can I close my fireplace damper to get more heat from my vented gas log set?

No. Vented gas logs are designed to be operated with the damper in the fully opened position. This gas log set produces carbon monoxide gas. The damper must be removed or clamped fully open using the "C" clamp provided with the set.

My gas logs make a whistling noise when I burn them. What causes this?

This behavior is normally caused by using a corrugated flex connector to hook up the gas log set. We recommend the installer use the supplied aluminum connector rather than the corrugated flexible type.

Can I move or change the position of the logs on my gas log set?

Certified log sets should not be altered - log placement must be exactly as indicated in the set's installation instructions.

Can I install my gas log set myself?

No. We recommend installation be performed by an NFI certified hearth professional, HVAC professional, gas fitter, or plumber experienced in gas log installation. Most localities require installation of any gas appliance to be performed by a professional. Please check with your local inspection agency/department.

What are the gas logs made of?

The gas logs are made of a mixture of pre-fired, expanded clay and a special high-temperature cement, with a wire mesh reinforcement. This combination creates a strong, ceramic material capable of withstanding extreme temperatures, yet also allows molding of the intricate detail found in these gas log sets.

I have a vented log set, and the logs have black soot on them. Is this normal?

Soot build-up on vented gas logs is a normal part of the combustion process. Natural gas log sets generally produce less soot than liquid propane log sets. We recommend any soot build up be removed periodically using a product designed for gas log soot removal.

Is the gas log set approved by a testing agency?

Yes. The ODGO series has been design certified by PFS under the **ANSI Z21.60b-2012 Decorative Appliances for Installation in Solid Fuel Burning Fireplaces**. The installation and the provisions for combustion and ventilation air must conform to the **National Fuel Gas Code, ANSI Z223.1/NFPA 54**. Check with your local inspections department for further information.

N. GO324 Grand Oak Series Logs

- Open the log box and remove the paper packaging and logs.
- Inspect each log for breakage that may have occurred during shipping and handling.



SRV737



SRV708



SRV709

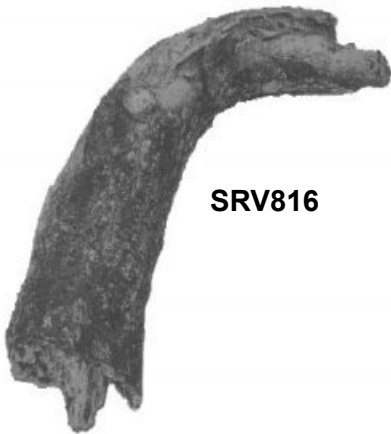

SRV816

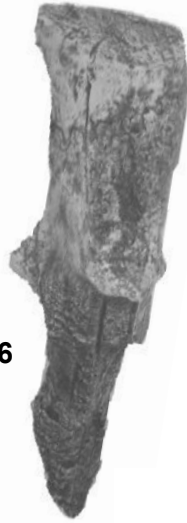

SRV716



SRV728



SRV808



SRV724



SRV706



SRV702



SRV707

O. GO324 Grand Oak Series Log Placement Instructions

- Place logs EXACTLY as the following photos depict.

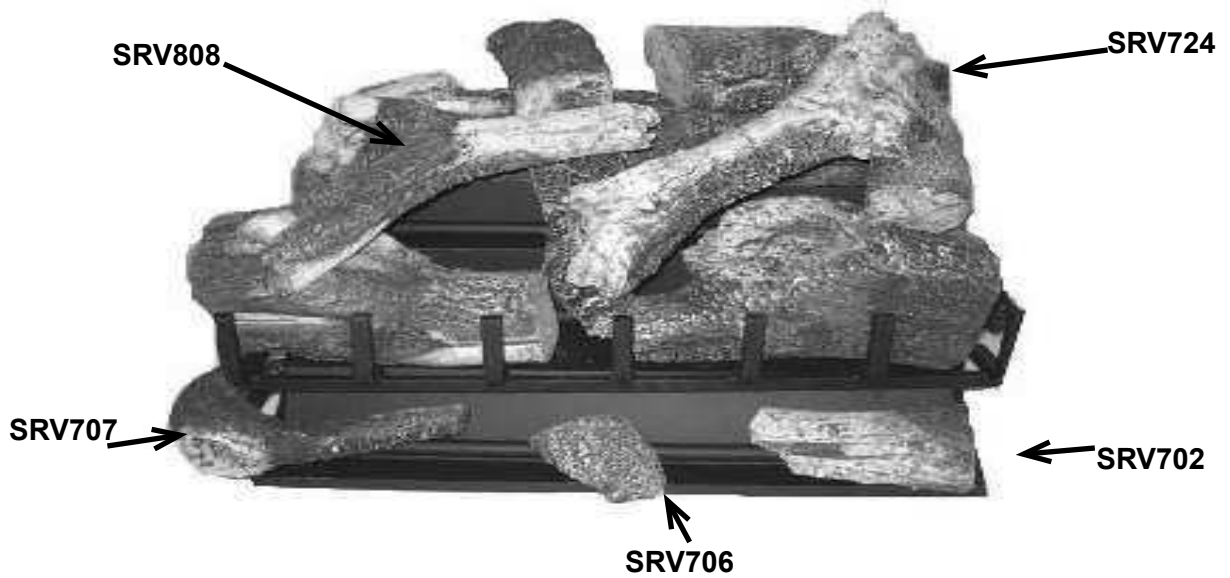
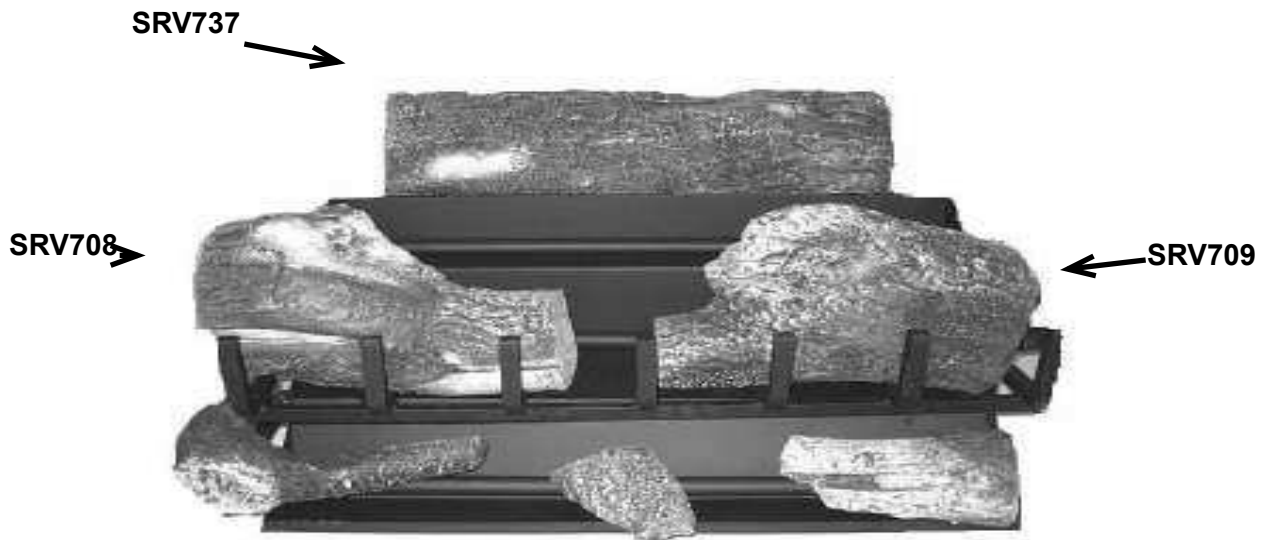

ODGO324

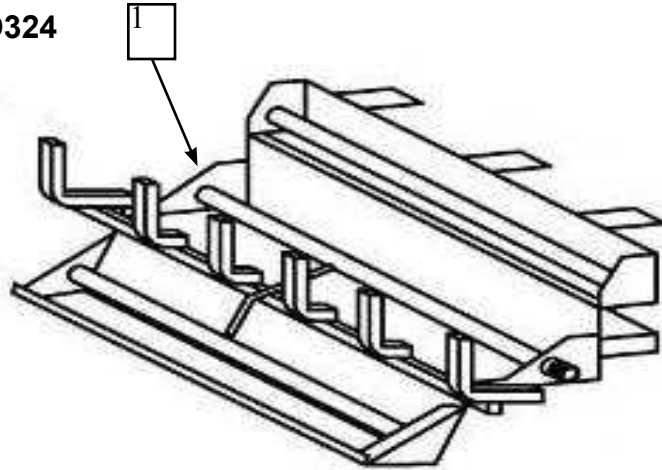

IPI Valve Assembly
ODGO 324

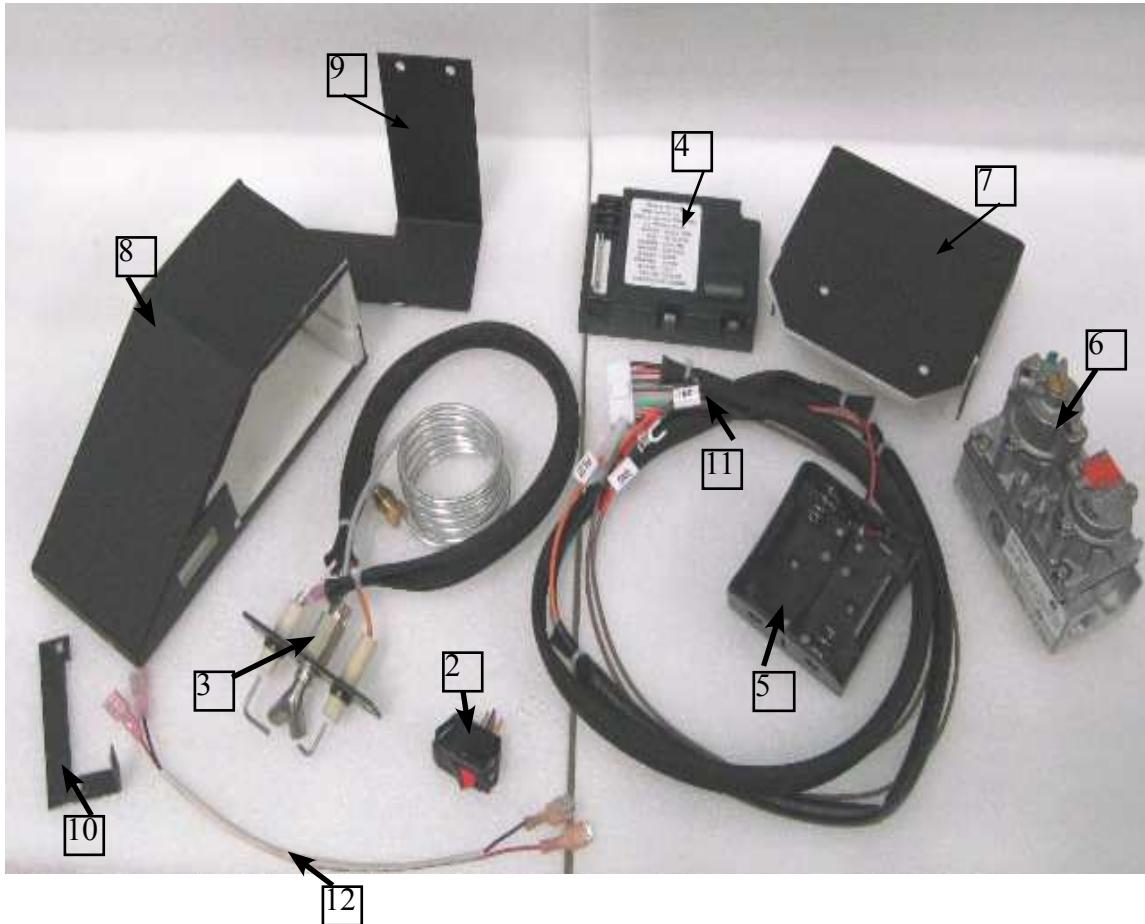

#	Description of Part	ODGO324	Qty.
1	Burner Pan & Grate Assembly (LP Gas)	SRVODGOIPI-LP	1
1	Burner Pan & Grate Assembly (Natural Gas)	SRVODGOIPI-NG	1
2	Switch	01-1070	1
3	*Pilot NG	07-1024	1
3	*Pilot LP	07-1023	1
4	Control Module	593-592	1
5	Battery Holder	593-594A	1
6	Valve NG	593-500	1
6	Valve LP	593-501	1
7	Valve Bracket	MT-350-VCSS	1
8	Control Box	MT-350-BBASS	1
9	Control Box Mount	MT-350-CBMSS	1
10	Pilot Bracket	MT-350-PBSS	1
11	Wire Harness	593-590A	1
12	Switch Wiring Harness (9")	16-1615	1
13	Battery Cover Log	H-0586A	1
14	Damper Stop Assy	SRV500-SC	1
15	Gas Line Connector	FT-1-24	1
	Lava Rock	SRVACC10	
	Installation Instructions	4004-320	

*Stock to Depot

Warranty

Outdoor Lifestyles by Hearth & Home Technologies, Inc.™ Limited Warranty

Hearth & Home Technologies, Inc. ("HHT") extends the following warranty for all Outdoor Lifestyles by HHT™ brand products ("Products") that are purchased from an HHT authorized dealer.

WARRANTY COVERAGE:

HHT warrants to the original owner of the Product at the site of installation, and to any transferee taking ownership of the Product at the site of installation within one year following the date of original purchase, that the Product will be free from defects in materials and workmanship at the time of manufacture. After installation, if covered components manufactured by HHT are found to be defective in materials or workmanship during the applicable warranty period, HHT will, at its option, repair or replace the covered components. This warranty is subject to conditions, exclusions and limitations as described below.

WARRANTY PERIOD:

The warranty period runs for one year, beginning on the earlier of: (i) the date of invoice for the Product; (ii) in the case of new home construction, the date of first occupancy of the residence or six months after the date of sale of the Product by an HHT authorized dealer, whichever occurs first; or (iii) the date 24 months following the date of Product shipment from HHT, regardless of the invoice or occupancy date.

WARRANTY CONDITIONS:

- This warranty only covers Products that are purchased through an HHT authorized dealer or distributor. A list of HHT authorized dealers is available on the HHT branded websites.
- This warranty is only valid while the Product remains at the site of original installation.
- Contact your installing dealer for warranty service. If the installing dealer is unable to provide necessary parts, contact the nearest HHT authorized dealer or supplier. Additional service fees may apply if you are seeking warranty service from a dealer other than the dealer from whom you originally purchased the Product.
- Check with your dealer in advance for any costs to you when arranging a warranty call. Travel and shipping charges for parts are not covered by this warranty.

WARRANTY EXCLUSIONS:

This warranty does not cover the following:

- Changes in surface finishes as a result of normal use. As a heating appliance, some changes in color of interior and exterior surface finishes may occur; this is not a flaw and not covered under warranty.
- Damage to printed, plated, or enameled surfaces caused by fingerprints, accidents, misuse, scratches, melted items, or other external sources and residues left on surfaces from the use of abrasive cleaners or polishes.
- Repair or replacement of parts that are subject to normal wear and tear during the warranty period. These parts include: paint, firebricks, grates, flame guides and the discoloration of glass.
- Minor expansion, contraction, or movement of certain parts causing noise. These conditions are normal and complaints related to this noise are not covered by this warranty.

- Damages resulting from: (1) failure to install, operate, or maintain the Product in accordance with the installation instructions, operating instructions, and listing agent identification label furnished with the Product; (2) failure to install the Product in accordance with local building codes; (3) shipping or improper handling; (4) improper operation, abuse, misuse, continued operation with damaged, corroded or failed components, accident, or incorrectly performed repairs; (5) inadequate ventilation, negative pressure or environmental conditions, including, without limitation: hail, snow, ice, fallen branches, flooding, water damage and fading of color; (6) use of fuels other than those specified in the operating instructions; (7) installation or use of components not supplied with the Product or any other components not expressly authorized and approved by HHT; (8) modification of the Product not expressly authorized and approved by HHT in writing; and/or (9) interruptions or fluctuations of electrical power supply to the Product.
- Non-HHT venting components, hearth components or other accessories used in conjunction with the Product.
- Any part of a pre-existing fireplace system in which an insert or a decorative gas appliance is installed.
- The Product's capability to heat the desired space. Information is provided to assist the consumer and the dealer in selecting the proper appliance for the application. Consideration must be given to the Product's location and configuration and environmental conditions.

This warranty is void if:

- The Product has been over-fired or operated in atmospheres contaminated by chlorine, fluorine, or other damaging chemicals. Over-firing can be identified by, but not limited to, warped plates or tubes, rust colored cast iron, bubbling, cracking and discoloration of steel or enamel finishes and cracking or spalling of refractory or cementitious materials.
- The Product is subjected to prolonged periods of dampness, condensation, ice or snow.
- There is any damage to the Product or other components due to water or weather damage which is the result of, but not limited to, improper chimney or venting installation.

LIMITATIONS OF LIABILITY:



Repair or replacement in accordance with the provisions of this warranty will be the owner's exclusive remedy for and will constitute HHT's sole obligation under this warranty, under any other warranty (express or implied), or in contract, tort or otherwise; provided, however, that if HHT is unable to provide repair or replacement in an expedient and cost effective manner, HHT may discharge all such obligations by refunding the purchase price of the Product. No employee, agent, dealer, or other person is authorized to give any warranty on behalf of HHT. TO THE EXTENT ALLOWED BY LAW, HHT MAKES NO OTHER WARRANTY, EXPRESS OR IMPLIED, INCLUDING ANY WARRANTY OF MERCHANTABILITY OR FITNESS FOR A PARTICULAR PURPOSE. HHT WILL NOT BE LIABLE FOR ANY CONSEQUENTIAL OR INCIDENTAL DAMAGES ARISING OUT OF DEFECTS IN OR USE OF THE PRODUCTS. Some states do not allow exclusions or limitation of incidental or consequential damages, so these limitations may not apply to you. This warranty gives you specific rights; you also may have other rights, which vary from state to state. The duration of any implied warranty is limited to the duration of the warranty period specified herein.

Contact Information



Please contact your Hearth & Home Technologies dealer with any questions or concerns.
For the number of your nearest Hearth & Home Technologies dealer, please call 1-800-927-6841 or 1-888-427-3973.

- NOTES -

CAUTION		
	DO NOT DISCARD THIS MANUAL	
<ul style="list-style-type: none">• Important operating and maintenance instructions included.	<ul style="list-style-type: none">• Read, understand and follow these instructions for safe installation and operation.	<ul style="list-style-type: none">• Leave this manual with party responsible for use and operation.